



LEGEND

-  ISOLATION VALVE
Fig. D191
-  COMMISSIONING VALVE
Fig. D941
-  Eccentric Weld Reducer

NOTES

- 1.00 BOTH F&R BRANCHES ARE 80 ϕ
- 2.00 TOTAL WEIGHT EACH RISER INCLUDING WATER 797 kg

Ch. Water Core 4

R.A. FORD Ltd	
H.V.A.C BUILDING SERVICES ENGINEERS	
<small>Unit 6, Canons Road, Canon Industrial Estate, Old Wolverton Milton Keynes, Bucks MK12 5TL</small>	
<small>T 01908 221007 F 01908 221300 E raford@btconnect.com</small>	
project DEVONSHIRE HOUSE - CORE 4 RISER - CHILLED WATER	
drawing no. SK2	date APRIL 07

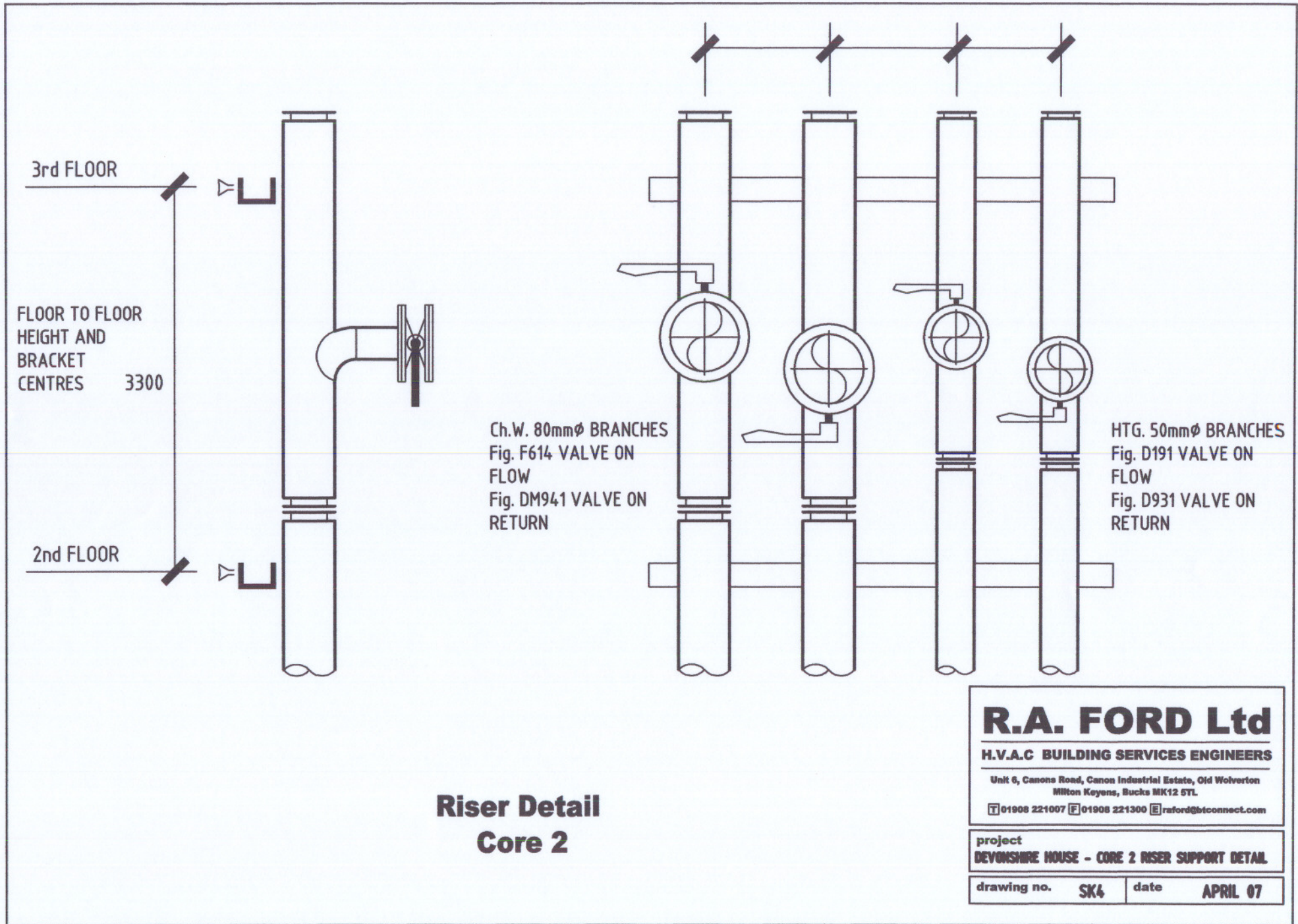



R.A. FORD Ltd
H.V.A.C BUILDING SERVICES ENGINEERS
 Unit 6, Canons Road, Canon Industrial Estate, Old Wolverton
 Milton Keynes, Bucks MK12 5TL
 T 01908 221007 F 01908 221300 E raford@btconnect.com

project
DEVONSHIRE HOUSE - CORE 2 RISER SUPPORT DETAIL

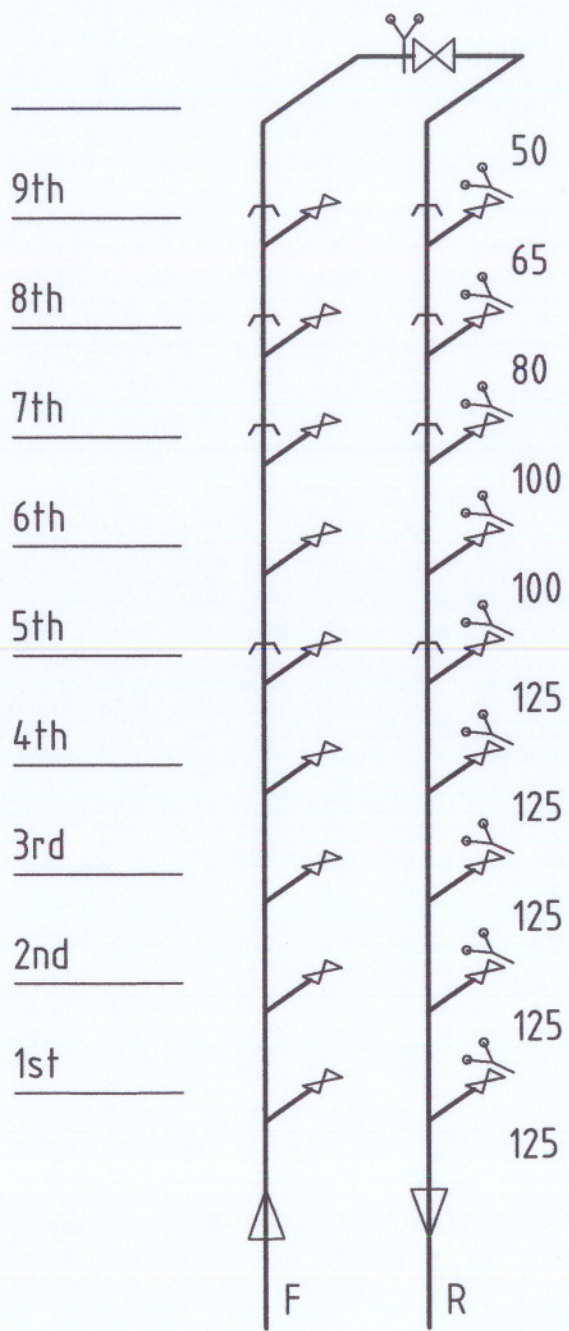
drawing no. **SK4** date **APRIL 07**



LEGEND

-  ISOLATION VALVE
Fig. D191
-  COMMISSIONING VALVE
Fig. D941
-  Eccentric Weld Reducer

NOTES

- 1.00 BOTH F&R BRANCHES ARE 50 ϕ
- 2.00 TOTAL WEIGHT EACH RISER INCLUDING WATER 797 kg

Heating Core 4

R.A. FORD Ltd
H.V.A.C BUILDING SERVICES ENGINEERS
 Unit 6, Canons Road, Canon Industrial Estate, Old Wolverton
 Milton Keynes, Bucks MK12 5TL
 T 01908 221007 F 01908 221300 E raford@btconnect.com

project
DEVONSHIRE HOUSE - CORE 4 RISER - HEATING

drawing no. **SK1** date **APRIL 07**

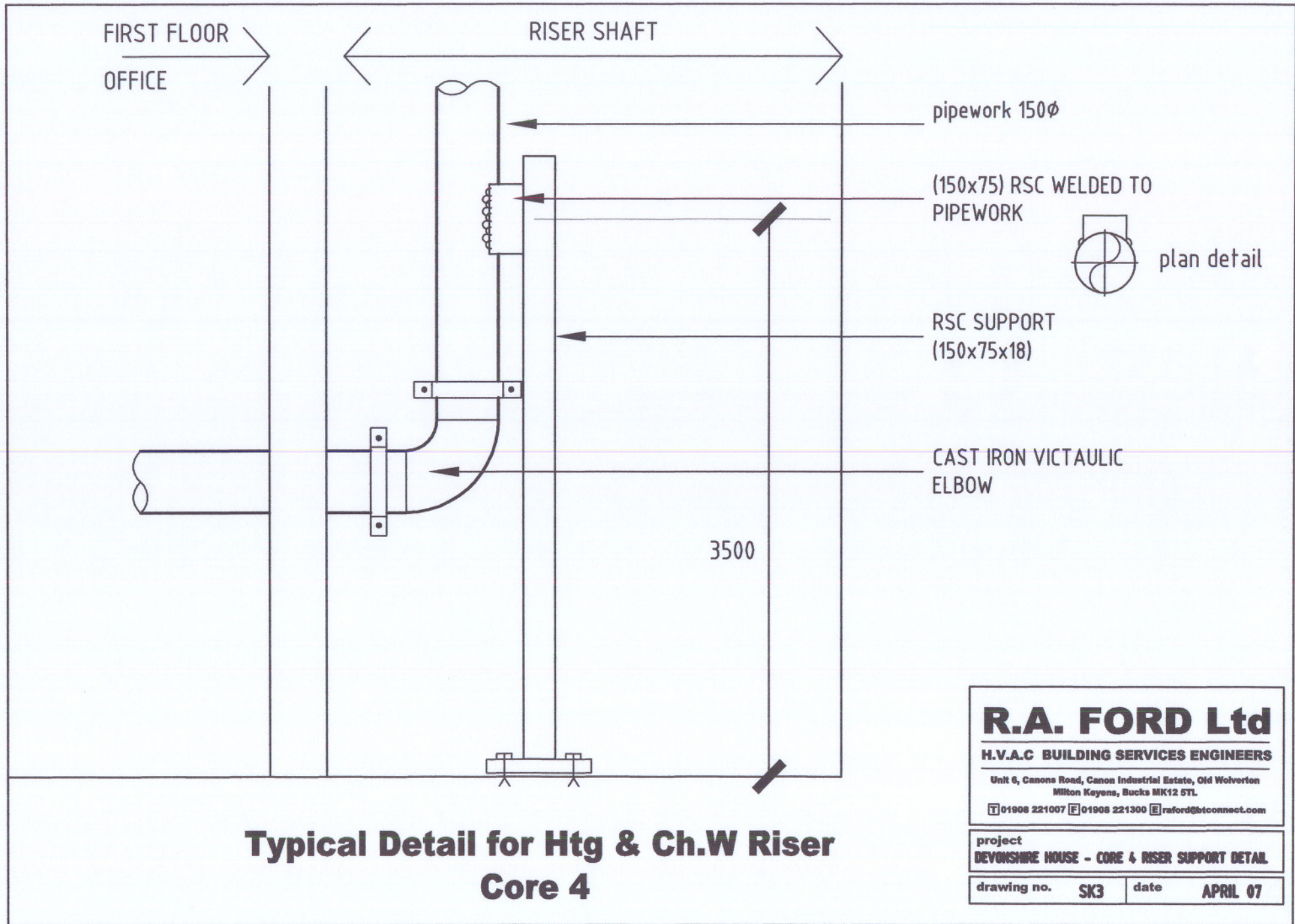

R.A. FORD Ltd
H.V.A.C BUILDING SERVICES ENGINEERS
 Unit 6, Canons Road, Canon Industrial Estate, Old Wolverton
 Milton Keynes, Bucks MK12 5TL
 T 01908 221007 F 01908 221300 E raford@btconnect.com

project
DEVONSHIRE HOUSE - CORE & RISER SUPPORT DETAIL

drawing no. **SK3** date **APRIL 07**

R. A. FORD Ltd

Contract: DEVONSHIRE House - Core 2 RISE

Drawing No: BASEMENT FLOOR PENETRATIONS - THROUGH INTO SUB-BASEMENT

